

■ **Features**

- High Luminous LEDs
- 3mm Round Standard Directivity
- UV Resistant Epoxy
- Water Clear Type

■ **Applications**

- Green House Applications
- Red : Blue LED Iv Ratio is 8:1*

*The ratio is summarized by the photosynthesis test on Phalaenopsis and provided from plant workshop in Taiwan.

■ **Outline Dimension**

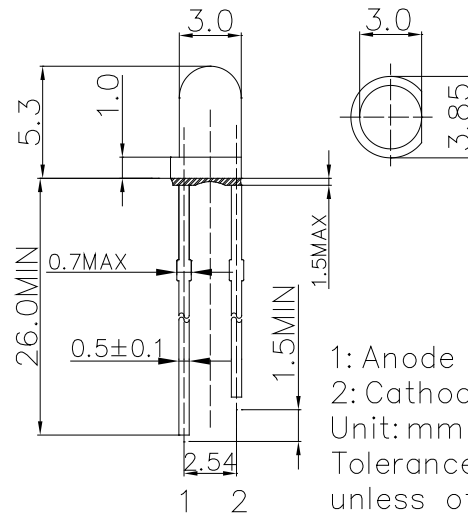

■ **Absolute Maximum Rating**

(Ta=25°C)

Item	Symbol	Value	Unit
DC Forward Current	I _F	30	mA
Pulse Forward Current#	I _{FP}	100	mA
Reverse Voltage	V _R	5	V
Power Dissipation	P _D	78	mW
Operating Temperature	T _{opr}	-30 ~ +85	°C
Storage Temperature	T _{stg}	-40 ~ +100	°C
Lead Soldering Temperature	T _{sol}	260°C/5sec	-

#Pulse width Max.10ms Duty ratio max 1/10

■ **Directivity**

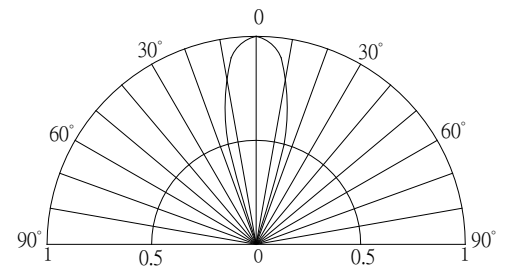

■ **Electrical -Optical Characteristics**

(Ta=25°C)

Item	Symbol	Condition	Min.	Typ.	Max.	Unit
DC Forward Voltage*1	V _F	I _F =20mA	-	2.1	2.6	V
DC Reverse Current	I _R	V _R =5V	-	-	10	μA
Peak Wavelength*2	λ _p	I _F =20mA	650	660	670	nm
Luminous Intensity*3	I _v	I _F =20mA	4000	5000	-	mcd
50% Power Angle	2θ _{1/2}	I _F =20mA	-	30	-	deg

*1 Tolerance of measurements of forward voltage is ±0.1V

*2 Tolerance of measurements of peak wavelength is ±1nm

*3 Tolerance of measurements of luminous intensity is ±15%

AlGaInP LED

TYPICAL ELECTRICAL/OPTICAL CHARACTERISTIC CURVES

