

■Features

- High Luminous Intensity
- 3mm Standard Directivity
- Long Lifetime Operation
- Superior UV Resistance
- Color Transparent Type

■Applications

- General Purpose Indicators
- Decorations
- Toys & Games
- General Use

■Outline Dimension

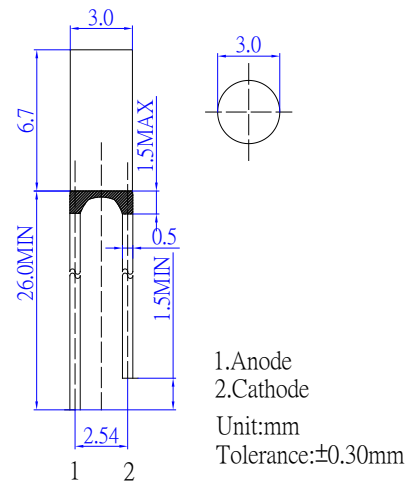

■Absolute Maximum Rating

(Ta=25°C)

Item	Symbol	Value		Unit
		B/PG	R/Y/YG	
DC Forward Current	I _F	30	30	mA
Pulse Forward Current#	I _{FP}	100	100	mA
Reverse Voltage	V _R	5	5	V
Power Dissipation	P _D	102	78	mW
Operating Temperature	T _{opr}	-30 ~ +85		°C
Storage Temperature	T _{stg}	-40 ~ +100		°C
Lead Soldering Temperature	T _{sol}	260°C/5sec		-





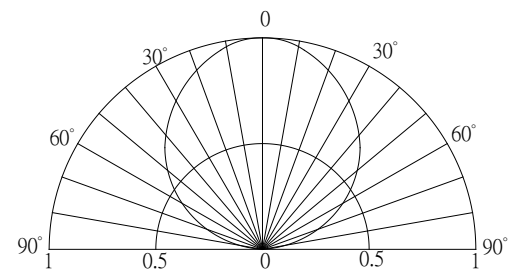

#Pulse width Max 0.1ms, Duty ratio max 1/10

■Directivity



■Electrical -Optical Characteristics

(Ta=25°C)

Part Number	Color			V _F (V)*			I _R (μA)	I _v (mcd)*			λD(nm)*			2θ1/2(deg)
				Min.	Typ.	Max.	Max.	Min.	Typ.	Max.	Min.	Typ.	Max.	Typ.
				I _F =20mA			V _R =5V		I _F =20mA					
OSB5YU39B3B	Blue	B		-	2.9	3.4	10	220	330	-	465	470	475	110
OSG5TA39B3B	Pure Green	PG		-	2.9	3.4	10	750	1120	-	520	525	530	110
OSG8HA39B3B	Yellow Green	YG		-	2.1	2.6	10	100	150	-	565	570	575	110
OSY5JA39B3B	Yellow	Y		-	2.1	2.6	10	150	220	-	585	590	595	110
OSO5JA39B3B	Orange	O		-	2.1	2.6	10	220	330	-	600	605	610	110
OSR5JA39B3B	Red	R		-	2.1	2.6	10	150	220	-	620	625	630	110

*1 Tolerance of measurements of dominant wavelength is ±1nm

*2 Tolerance of measurements of luminous intensity is +15%

*3 Tolerance of measurements of forward voltage is ±0.1V