

■ **Features**

- High Luminous LEDs
- 8mm Round Standard Directivity
- Color Changing Type
- White Diffused Type

■ **Applications**

- Toys
- Games
- Audio
- Other Lighting

■ **Outline Dimension**

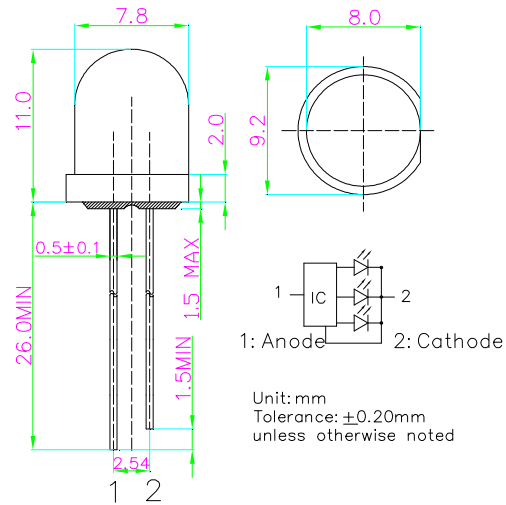

■ **Absolute Maximum Rating**

(Ta=25°C)

Item	Symbol	Value	Unit
Power Supply	Voltage	5	V
Operating Temperature	Topr	-30 ~ +85	°C
Storage Temperature	Tstg	-40~ +100	°C
Lead Soldering Temperature	Tsol	260°C/5sec	-

■ **Directivity**

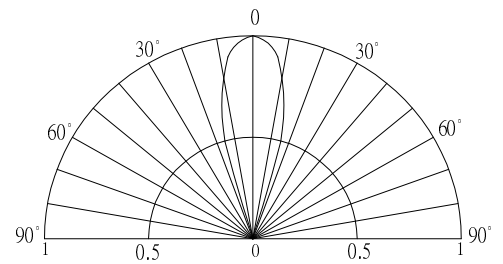

■ **Electrical -Optical Characteristics**

(Ta=25°C)

Item	Symbol	Conditio	Min.	Typ.	Max.	Unit
DC Forward Voltage*1	V _{dd}	I _F =20mA	3.8	4.5	5.0	V
Oscillator Frequency*2	F _{led}	I _F =20mA	-	12	-	S
Duty Cycle	Duty	I _F =20mA	-	-	-	-
Domi. Wavelength*3	λ _D (Red)	I _F =20mA	620	625	630	nm
	λ _D (Blue)	I _F =20mA	460	465	475	nm
	λ _D	I _F =20mA	520	525	530	nm
Luminous Intensity*4	I _v (Red)	I _F =20mA	3000	4000	-	mcd
	I _v (Blue)	I _F =20mA	1560	2180	-	mcd
	I _v (Green)	I _F =20mA	5800	7000	-	mcd
50% Power Angle	2θ _{1/2}	I _F =20mA	-	30	-	deg

■ **Waveform Diagram**

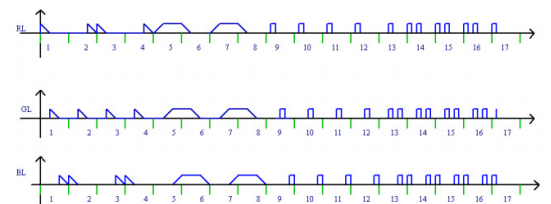

*Tolerance of Blinking Cycle is ±20%

*1 Tolerance of measurements of forward voltage is ±0.1V

*2 Tolerance of measurements of Frequency is ±20%

*3 Tolerance of measurements of dominant wavelength is ±1nm

*4 Tolerance of measurements of luminous intensity is ±15%