



■ Description

- LED Kit contains LEDs, resistors and mounting clips
- 560pcs are supplied in a storage box
- Easy to use and storage
- Widely applied to DIY projects, school science experiments, car decorations, etc.

■ Features

- 3mm & 5mm round standard 30° directivity
- UV resistant epoxy
- Red/Yellow/Yellow Green/Blue/Warm White/Cool White
- Color diffused/Water clear
- Resistors are used to limit current flow
- Single part clips for mounting

■ Product Picture

560pcs/Box (Dimensions: 195*130*36mm)



■ Kit Contents

Section	Contents	Pcs	P/N	Spec
1	3mm LED, Red	20	OSR63134A	Page 2
2	3mm LED, Yellow	20	OSY53134A	
3	3mm LED, Blue	20	OSB53134A	
4	3mm LED, Yellow Green	20	OSG83134A	
5	3mm LED, Warm White	20	OSM53131A	
6	3mm LED, Cool White	20	OSW53131A	
7	3mm LED Mounting Clip	40		Page 3
8	5mm LED, Red	20	OSR65134A	Page 2
9	5mm LED, Yellow	20	OSY55134A	
10	5mm LED, Blue	20	OSB55134A	
11	5mm LED, Yellow Green	20	OSG85134A	
12	5mm LED, Warm White	20	OSM55131A	
13	5mm LED, Cool White	20	OSW55131A	
14	5mm LED Mounting Clip	40		Page 3
15	220Ω Carbon Film Resistor, 0.25W±0.5%	60		Page 4
16	470Ω Carbon Film Resistor, 0.25W±0.5%	60		
17	680Ω Carbon Film Resistor, 0.25W±0.5%	60		
18	1000Ω Carbon Film Resistor, 0.25W±0.5%	60		

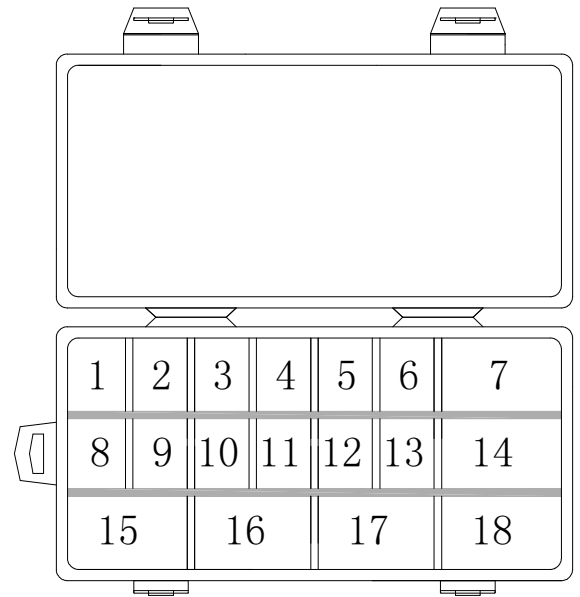

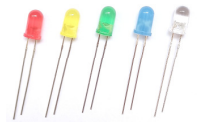

■Description

- 3mm & 5mm round standard 30° directivity
- UV resistant epoxy
- Available in all colors
- Color diffused/Water clear

■Applications

- General purpose indicators
- Small area illuminations
- Christmas light
- Backlighting

■Outline Dimension

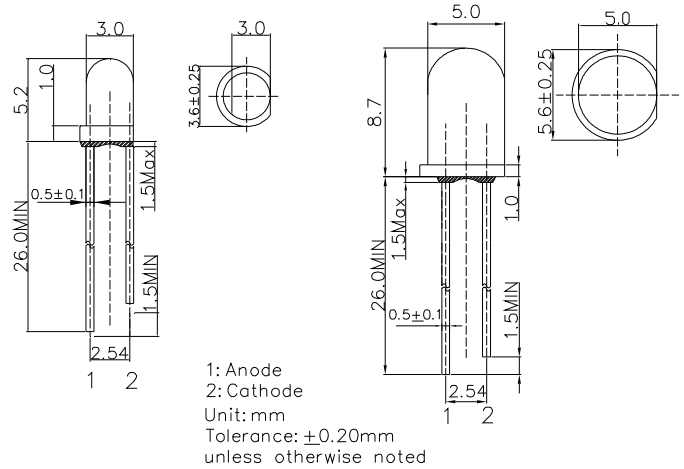

■Absolute Maximum Rating (Ta=25°C)

Item	Symbol	Value		Unit
		B/M/W	R/Y/YG	
DC Forward Current	I _F	30	30	mA
Pulse Forward Current#	I _{FP}	100	100	mA
Reverse Voltage	V _R	5	5	V
Power Dissipation	P _D	102	72	mW
Operating Temperature	T _{opr}	-30 ~ +85		°C
Storage Temperature	T _{stg}	-40 ~ +100		°C
Lead Soldering Temperature	T _{sol}	260°C/5sec		-

#Pulse width Max.10ms Duty ratio max 1/10

■Directivity

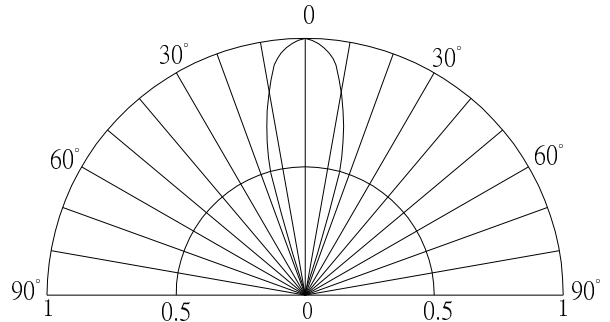

■Electrical -Optical Characteristics (Ta=25°C)

3mm LED						
LED P/N	OSR63134A	OSY53134A	OSG83134A	OSB53134A	OSM53131A	OSW53131A
Light Color	Red	Yellow	Yellow Green	Blue	Warm White	Cool White
Lens Color	Red Diffused	Yellow Diffused	Green Diffused	Blue Diffused	Water Clear	Water Clear
Wavelength*1/Color Temperature*2	620-640nm	585-595nm	565-575nm	462.5-472.5nm	2700-3300K	8500-18000K
Luminous Intensity(typ.)*3	330mcd	420mcd	55mcd	2500mcd	14400mcd	14400mcd
Forward Voltage*4	1.8-2.4V	1.8-2.4V	1.8-2.4V	2.7-3.4V	2.7-3.4V	2.7-3.4V
Forward Current	20mA	20mA	20mA	20mA	20mA	20mA
Viewing Angle(typ.)	30°	30°	30°	30°	30°	30°
Quantity(pcs)/Box	20	20	20	20	20	20

5mm LED						
LED P/N	OSR65134A	OSY55134A	OSG85134A	OSB55134A	OSM55131A	OSW55131A
Light Color	Red	Yellow	Yellow Green	Blue	Warm White	Cool White
Lens Color	Red Diffused	Yellow Diffused	Green Diffused	Blue Diffused	Water Clear	Water Clear
Wavelength*1/Color Temperature*2	620-640nm	585-595nm	565-575nm	462.5-472.5nm	2700-3300K	8500-18000K
Luminous Intensity(typ.)*3	420mcd	420mcd	90mcd	2180mcd	19000mcd	19000mcd
Forward Voltage*4	1.8-2.4V	1.8-2.4V	1.8-2.4V	2.7-3.4V	2.7-3.4V	2.7-3.4V
Forward Current	20mA	20mA	20mA	20mA	20mA	20mA
Viewing Angle(typ.)	30°	30°	30°	30°	30°	30°
Quantity(pcs)/Box	20	20	20	20	20	20

*1 Tolerance of measurements of dominant wavelength is ± 1 nm

*2 Tolerance of measurements of color temperature is $\pm 10\%$

*3 Tolerance of measurements of luminous intensity is $\pm 15\%$

*4 Tolerance of measurements of forward voltage is ± 0.1 V

Material	NYLON66
Color	Black
Fireproofing Grade	94V-2
Tolerance	±0.2mm

■Product Information & Outline Dimension:

Item	A	B	C	D	E	F
3mm LED Mounting Clip	Φ4.5	Φ6.0	Φ3.1	1.4	6.0	Φ4.4
5mm LED Mounting Clip	Φ6.4	Φ7.8	Φ5.1	1.5	7.5	Φ6.0

Unit: mm

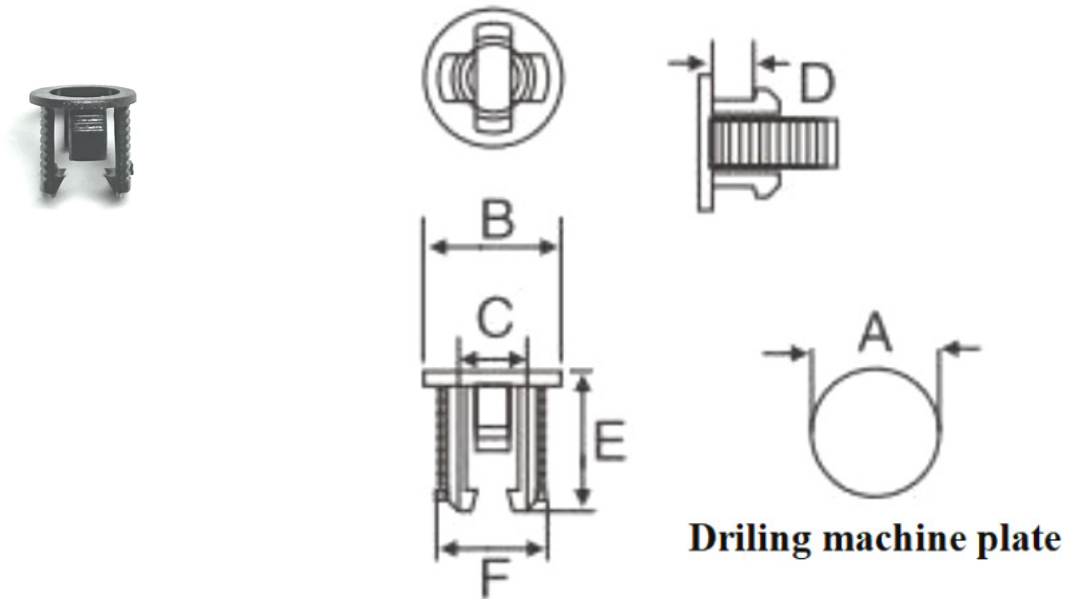

■ Specifications

Power Rating	Maximum Working Voltage	Maximum Overload Voltage	Dimension (mm)					Resistance Range
			A ± 2	B	C	D	E ± 0.1	
1/8W	200V	400V	60	28±2.0	3.2±0.2	1.8±0.2	0.35	0.1E-22M
1/6W	200V	400V	60	28±2.0	3.2±0.2	1.8±0.2	0.35	
1/4Ws	250V	500V	60	28±2.0	6.0±0.5	2.3±0.3	0.35	
1/4W	250V	500V	60	28±2.0	6.0±0.5	2.3±0.3	0.35	
1/2ws	350V	700V	60	26±2.0	9.0±0.5	3.2±0.5	0.35	
1/2w	350V	700V	60	26±2.0	9.0±0.5	3.2±0.5	0.38	
1WS	500V	1000V	60	25±2.0	11.0±1.0	3.7±0.5	0.38	
1W	500V	1000V	60	24±2.0	15.0±1.0	5.0±0.5	0.40	
2W	500V	1000V	63	32±2.0	17.0±1.0	6.0±0.5	0.50	
3WS	500V	1000V	63	28±2.0	24.0±1.0	8.0±0.5	0.50	
3W	500V	1000V	81	28±2.0	3.2±0.2	1.8±0.2	0.68	
5W	500V	1000V	81	28±2.0	3.2±0.2	1.8±0.2	0.68	

■ Color Coding

Color	1 st digit	2 nd digit	Multiplier	Tolerance
Black	0	0	1Ω	
Silver			0.01Ω	±10%
Golden			0.1Ω	±5%
Brown	1	1	10Ω	±1%
Red	2	2	100Ω	±2%
Orange	3	3	1KΩ	
Yellow	4	4	10KΩ	
Green	5	5	100KΩ	±0.5%
Blue	6	6	1MΩ	±0.25%
Violet	7	7	10MΩ	±0.1%
Gray	8	8		
White	9	9		

