

■Features

- High Luminous LEDs
- 8mm Round Standard Directivity
- UV Resistant Epoxy
- Water Clear Type

■Applications

- Toys
- Games
- Audio
- Other Lighting

■Outline Dimension

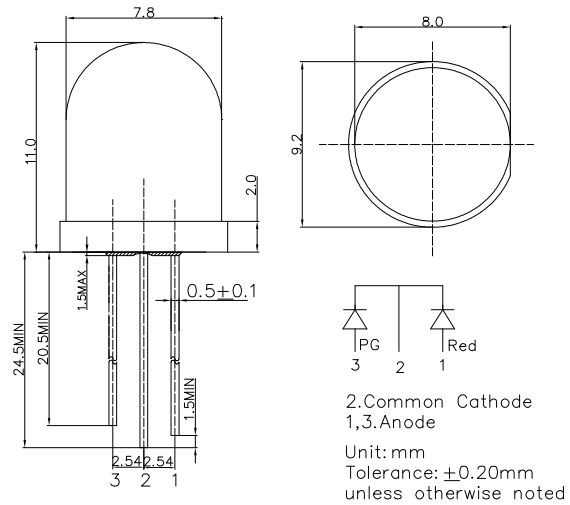

■Absolute Maximum Rating (Ta=25°C)

Item	Symbol	Value		Unit
		Red	PG	
DC Forward Current	I _F	30	30	mA
Pulse Forward Current#	I _{FP}	100	100	mA
Reverse Voltage	V _R	5	5	V
Power Dissipation	P _D	78	108	mW
Operating Temperature	Topr	-30~ +85		°C
Storage Temperature	Tstg	-40 ~ +100		°C
Lead Soldering Temperature	Tsol	260°C /5sec		-

■Directivity

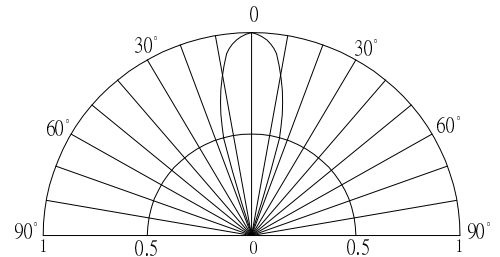

#Pulse width Max.10ms Duty ratio max 1/10

■Electrical -Optical Characteristics (Ta=25°C)

Item	Symbol	Condition	Min.	Typ.	Max.	Unit
DC Forward Voltage*1	V _F (Red)	I _F =20mA	-	2.1	2.6	V
	V _F (PG)	I _F =20mA	-	3.1	3.6	V
DC Reverse Current	I _R	V _R =5V	-	-	10	μA
Domi. Wavelength*2	λ _D (Red)	I _F =20mA	620	625	630	nm
	λ _D (PG)	I _F =20mA	520	525	530	nm
Luminous Intensity*3	I _v (Red)	I _F =20mA	5800	7000	-	mcd
	I _v (PG)	I _F =20mA	7000	8400	-	mcd
50% Power Angle	2θ _{1/2}	I _F =20mA	-	30	-	deg

*1 Tolerance of measurements of forward voltage is ±0.1V

*2 Tolerance of measurements of dominant wavelength is ±1nm

*3 Tolerance of measurements of luminous intensity is ±15%