

■Features

- High Luminous LEDs
- 4.7x5.7mm Standard Directivity
- UV Resistant Epoxy
- Water Clear Type

■Applications

- Electronic Signs And Signals
- Small Area Illuminations
- Back Lighting
- Other Lighting

■Outline Dimension

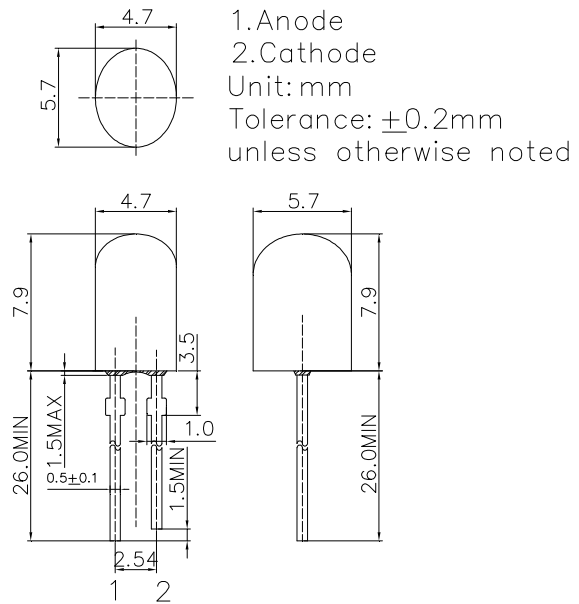

■Absolute Maximum Rating

(Ta=25°C)

Item	Symbol	Value	Unit
DC Forward Current	I _F	30	mA
Pulse Forward Current#	I _{FP}	100	mA
Reverse Voltage	V _R	5	V
Power Dissipation	P _D	102	mW
Operating Temperature	T _{opr}	-30~ +85	°C
Storage Temperature	T _{stg}	-40 ~ +100	°C
Lead Soldering Temperature	T _{sol}	260°C/5sec	-

■Directivity

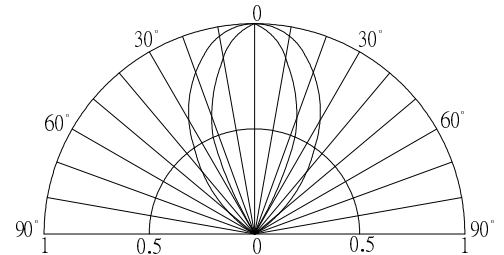

#Pulse width Max.10ms , Duty ratio max 1/10

■Electrical -Optical Characteristics

(Ta=25°C)

Item	Symbol	Condition	Min.	Typ.	Max.	Unit
DC Forward Voltage*1	V _F	I _F =20mA	-	2.9	3.4	V
DC Reverse Current	I _R	V _R =5V	-	-	10	μA
Domi. Wavelength*2	λ _D	I _F =20mA	520	525	530	nm
Luminous Intensity*3	I _v	I _F =20mA	7000	8400	-	mcd
50% Power Angle	2θ _{1/2}	I _F =20mA	-	40/70	-	deg

*1 Tolerance of measurements of forward voltage is ± 0.1 V

*2 Tolerance of measurements of dominant wavelength is ± 1 nm

*3 Tolerance of measurements of luminous intensity is ± 15 %