

■ Features

- High Luminous LEDs
- 8mm Round Standard Directivity
- Long Lifetime Operation
- UV Resistant Epoxy
- Water Clear Type
- Bi-polar Type

■ Applications

- Toys
- Audio
- Games
- Other Lighting

■ Outline Dimension

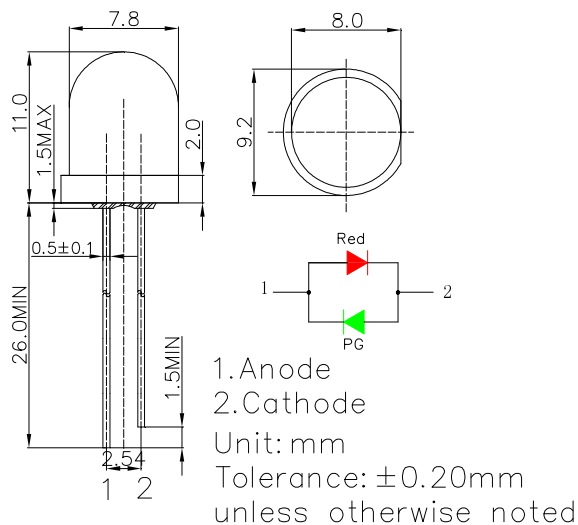

■ Absolute Maximum Rating

(Ta=25°C)

Item	Symbol	Value		Unit
		Red	PG	
DC Forward Current	I _F	50	30	mA
Pulse Forward Current#	I _{FP}	100	100	mA
Reverse Voltage	V _R	5	5	V
Power Dissipation	P _D	130	102	mW
Operating Temperature	T _{opr}	-30~ +85		°C
Storage Temperature	T _{stg}	-40 ~ +100		°C
Lead Soldering Temperature	T _{sol}	260°C/5sec		-

#Pulse width Max.10ms Duty ratio max 1/10

■ Directivity

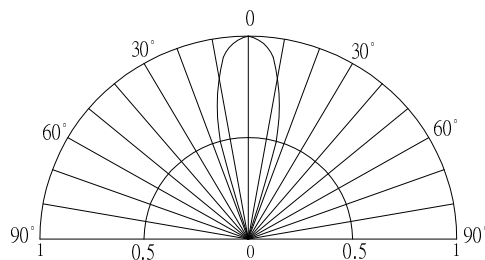

■ Electrical -Optical Characteristics

(Ta=25°C)

Item	Symbol	Condition	Min.	Typ.	Max.	Unit
DC Forward Voltage*1	V _F (Red)	I _F =20mA	-	2.1	2.6	V
	V _F (PG)	I _F =20mA	-	2.9	3.4	V
DC Reverse Current	I _R	V _R =5V	-	-	10	μA
Domi. Wavelength*2	λ _D (Red)	I _F =20mA	620	625	630	nm
	λ _D (PG)	I _F =20mA	520	525	530	nm
Luminous Intensity*3	I _v (Red)	I _F =20mA	4200	5800	-	mcd
	I _v (PG)	I _F =20mA	7000	8400	-	mcd
50% Power Angle	2θ _{1/2}	I _F =20mA	-	30	-	deg

*1 Tolerance of measurements of forward voltage is ±0.1V

*2 Tolerance of measurements of dominant wavelength is ±1nm

*3 Tolerance of measurements of luminous intensity is ±15%