

■ **Features**

- High Luminous LEDs
- 5mm Round Standard Directivity
- UV Resistant Epoxy
- Water Clear Type
- Perfect Beam Pattern

■ **Applications**

- Advertising Board
- Horticulture Application
- Traffic Light / Signal Light
- Beauty Product
- Other Lighting

■ **Outline Dimension**

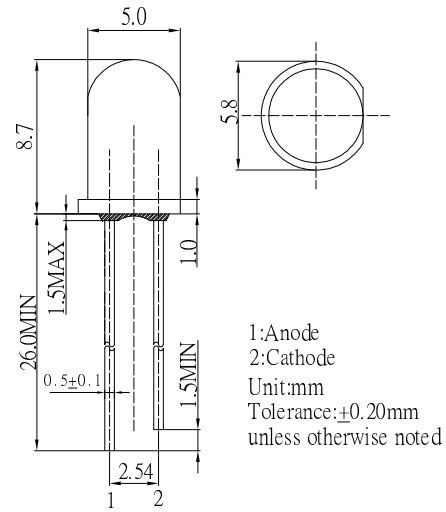

■ **Absolute Maximum Rating (Ta=25°C)**

Item	Symbol	Value	Unit
DC Forward Current	I _F	30	mA
Pulse Forward Current#	I _{FP}	100	mA
Reverse Voltage	V _R	5	V
Power Dissipation	P _D	102	mW
Operating Temperature	Topr	-30 ~ +85	°C
Storage Temperature	Tstg	-40~ +100	°C
Lead Soldering Temperature	Tsol	260°C/5sec	-

#Pulse width Max.10ms Duty ratio max 1/10

■ **Directivity**

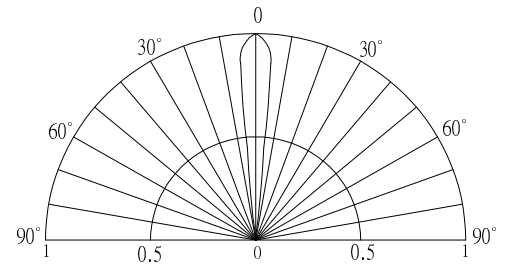

■ **Electrical -Optical Characteristics (Ta=25°C)**

Item	Symbol	Condition	Min.	Typ.	Max.	Unit
DC Forward Voltage*	V _F	I _F =30mA	2.7	2.9	3.4	V
DC Reverse Current	I _R	V _R =5V	-	-	10	μA
Luminous Flux	Φ _v	I _F =30mA	8.5	10	-	lm
Luminous Intensity*	I _v	I _F =30mA	43	60	-	cd
Color Temperature	CCT	I _F =30mA	-	3000	-	K
Chromaticity Coordinates*	x	I _F =30mA	-	0.44	-	
	y	I _F =30mA	-	0.41	-	
50% Power Angle	2θ _{1/2}	I _F =30mA	-	15	-	deg

*1 Tolerance of measurements of chromaticity coordinates is ±10%

*2 Tolerance of measurements of luminous intensity is ±15%

*3 Tolerance of measurements of forward voltage is ±0.1V