

■Features

- High Luminous PLCC2 Top SMD LEDs
- 3.5x2.8x1.7mm Standard Directivity
- Long Lifetime Operation
- Green Diffused Type

■Applications

- Backlighting (switches, keys, displays, illuminated advertising etc.)
- Substitution of Micro Incandescent Lamps
- Reading Lamps / Emergency Lighting
- Marker lights (e.g. steps, exit ways, etc.)
- Other Lighting

■Outline Dimension

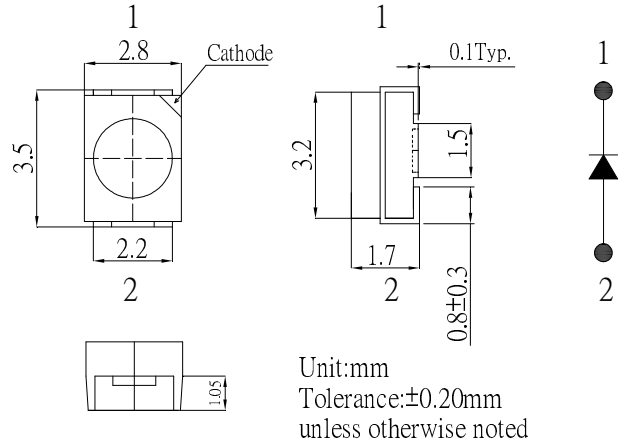

■Absolute Maximum Rating

(Ta=25°C)

Item	Symbol	Value	Unit
DC Forward Current	I _F	30	mA
Pulse Forward Current#	I _{FP}	100	mA
Reverse Voltage	V _R	5	V
Power Dissipation	P _D	108	mW
Operating Temperature	T _{opr}	-30 ~ +85	°C
Storage Temperature	T _{stg}	-40 ~ +100	°C
Lead Soldering Temperature	T _{sol}	260°C /5sec	-

#Pulse width Max.10ms Duty ratio max 1/10

■Directivity

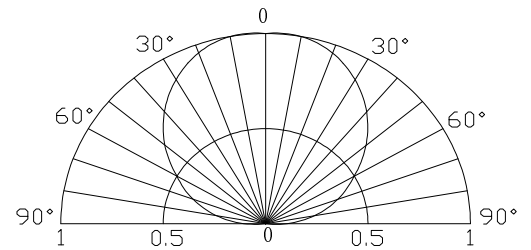

■Electrical -Optical Characteristics

(Ta=25°C)

Item	Symbol	Condition	Min.	Typ.	Max.	Unit
DC Forward Voltage*3	V _F	I _F =20mA	2.8	3.1	3.6	V
DC Reverse Current	I _R	V _R =5V	-	-	10	μA
Luminous Flux*2	Φ _v	I _F =20mA	8.6	9.3	-	lm
Chromaticity Coordinates*1	x	I _F =20mA	-	0.27	-	
	y	I _F =20mA	-	0.55	-	
50% Power Angle	2θ _{1/2}	I _F =20mA	-	120	-	deg

*1 Tolerance of measurements of chromaticity coordinate is ±10%

*2 Tolerance of measurements of luminous flux is ±15%

*3 Tolerance of measurements of forward voltage is ±0.1V

■ Soldering Conditions

Reflow Soldering		Hand Soldering	
Pre-Heat	180 ~ 200°C	Temperature Soldering time	350°C Max. 3 sec. Max. (one time only)
Pre-Heat Time	120 sec. Max.		
Peak temperature	260°C Max.		
Dipping Time	10 sec. Max.		
Condition	Refer to Temperature-profile		

• Reflow Soldering Condition(Lead-free Solder)

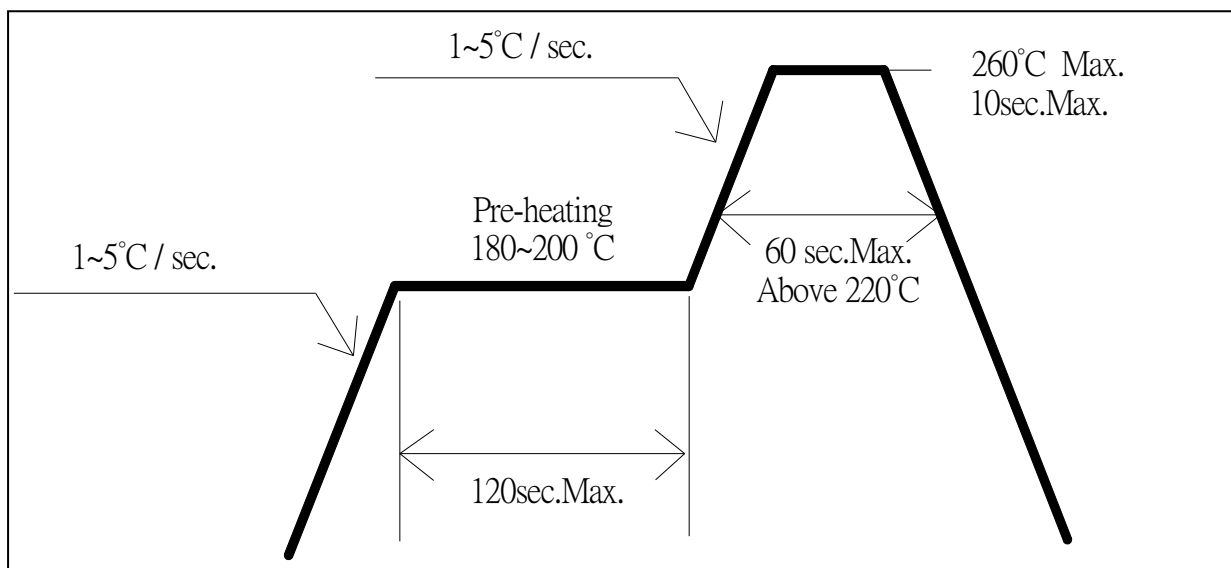

*Recommended soldering conditions vary according to the type of LED

*Although the recommended soldering conditions are specified in the above table, reflow, or hand soldering at the lowest possible temperature is desirable for the LEDs.

*A rapid-rate process is not recommended for cooling the LEDs down from the peak temperature.

- All SMD LED products are pb-free soldering available.
- Occasionally there is a brightness decrease caused by the influence of heat or ambient atmosphere during air reflow. It is recommended that the User use the nitrogen reflow method.
- Repairing should not be done after the LEDs have been soldered. When repairing is unavoidable a double-head soldering iron should be used. It should be confirmed beforehand whether the characteristics of the LEDs will or will not be damaged by repairing.
- Reflow soldering should not be done more than two times.
- When soldering, do not put stress on the LEDs during heating.
- After soldering, do not warp the circuit board.

PACKING DIMENTIONS

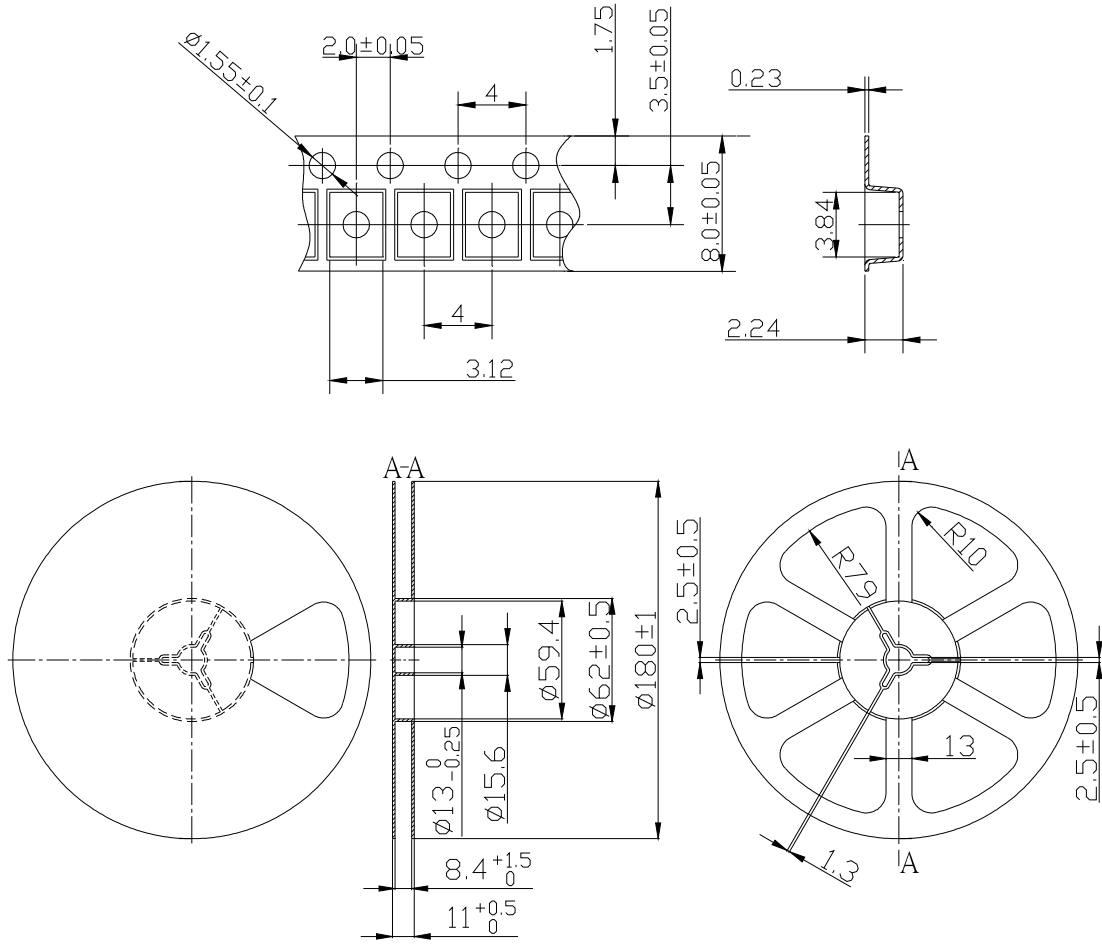

Notes:

1. Unit: mm
2. 2000pcs/Reel

Precautions in Use for Surface Mount Diode

■ Storage

· Storage Conditions

Before opening the package:

The LEDs should be kept at 30°C or less and 60%RH or less. The LEDs should be used within a year. When storing the LEDs, moisture proof packaging with absorbent material (silica gel) is recommended.

· After opening the package:

Soldering should be done right after opening the package (within 24hrs).

Keeping of a fraction, sealing and Temperature: 5~30°C Humidity: Less than 30%.

If the package has been opened more than 24 Hours, components should be dried for 12hrs, at 60±5°C.

· Optosupply LED electrode sections are comprised of a silver plated copper alloy. The silver surface may be affected by environments which contain corrosive gases and so on. Please avoid conditions which may cause the LED to corrode, tarnish or discolor. This corrosion or discoloration may cause difficulty during soldering operations. It is recommended that the User use the LEDs as soon as possible.

· Please avoid rapid transitions in ambient temperature, especially in high humidity environments where condensation can occur.