

■ **Features**

- High luminous Flux LEDs
- 4.8mm Straw Standard Directivity
- Superior Weather-resistance
- UV Resistant Epoxy
- Water Clear Type

■ **Applications**

- Backlighting (illuminated advertising etc.)
- Substitution of Micro Incandescent Lamps
- Reading Lamps / Emergency Lighting
- Marker lights (e.g. steps, exit ways, etc.)
- Other Lighting

■ **Outline Dimension**

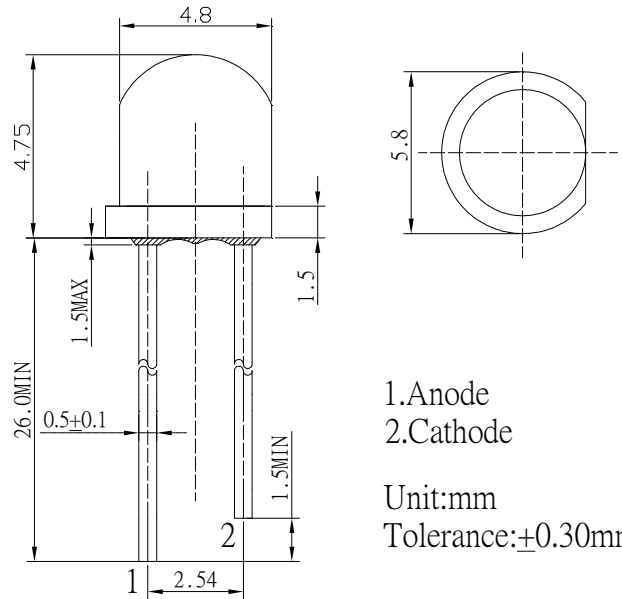

1. Anode
2. Cathode

Unit:mm
Tolerance:±0.30mm

■ **Absolute Maximum Rating**

(Ta=25°C)

Item	Symbol	Value	Unit
DC Forward Current	I _F	60	mA
Pulse Forward Current*	I _{FP}	120	mA
Reverse Voltage	V _R	5	V
Power Dissipation	P _D	216	mW
Operating Temperature	Topr	-30 ~ +85	°C
Storage Temperature	Tstg	-40 ~ +100	°C
Lead Soldering Temperature	Tsol	260°C/5sec	-

*Pulse width Max 10ms , Duty ratio max 1/10

■ **Directivity**

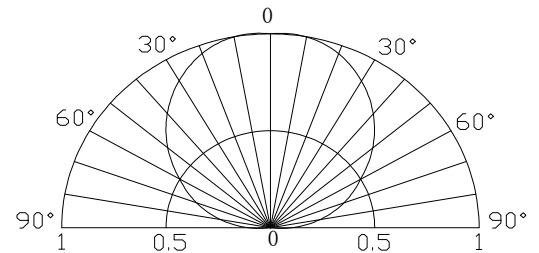

■ **Electrical -Optical Characteristics**

(Ta=25°C)

Item	Symbol	Condition	Min.	Typ.	Max.	Unit
DC Forward Voltage	V _F	I _F =50mA	2.9	3.1	3.6	V
DC Reverse Current	I _R	V _R =5V	-	-	10	μA
Luminous Flux	Φ _v	I _F =50mA	16	18	-	lm
Color Rendering Index	Ra	I_F=50mA	90	-	-	
Color Temperature	CCT	I _F =50mA	-	3000	-	K
Chromaticity Coordinates*	x	I _F =50mA	-	0.42	-	
	y	I _F =50mA	-	0.37	-	
50% Power Angle	2θ _{1/2}	I _F =50mA	-	120	-	deg

*1 Tolerance of measurements of chromaticity coordinate is ±10%

*2 Tolerance of measurements of luminous flux is ±15%

*3 Tolerance of measurements of forward voltage is ±0.1