

■ **Features**

- High Luminous LEDs
- 8mm Round Standard Directivity
- UV Resistant Epoxy
- Water Clear Type

■ **Applications**

- Electronic Signs And Signals
- Small Area Illuminations
- Back Lighting
- Other Lighting

■ **Outline Dimension**

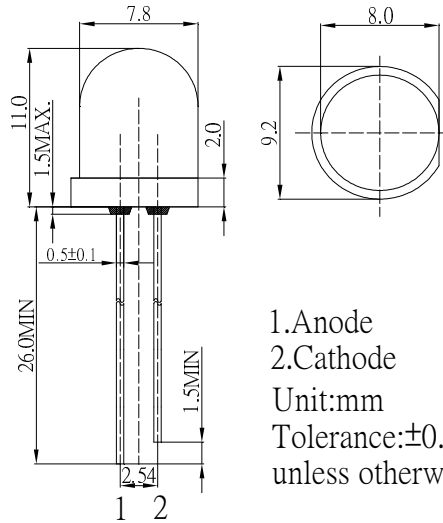

1. Anode
2. Cathode
Unit:mm
Tolerance:±0.20mm
unless otherwise noted

■ **Absolute Maximum Rating** (Ta=25°C)

Item	Symbol	Value	Unit
DC Forward Current	I _F	30	mA
Pulse Forward Current#	I _{FP}	100	mA
Reverse Voltage	V _R	5	V
Power Dissipation	P _D	108	mW
Operating Temperature	Topr	-30 ~ +85	°C
Storage Temperature	Tstg	-40 ~ +100	°C
Lead Soldering Temperature	Tsol	260°C/5sec	-

■ **Directivity**

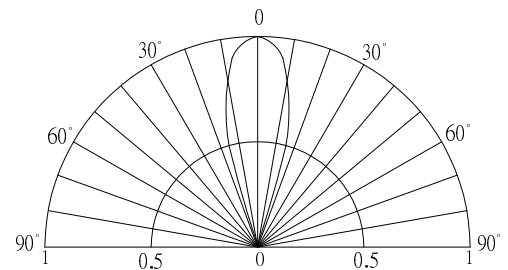

#Pulse width Max 10ms , Duty ratio max 1/10

■ **Electrical -Optical Characteristics** (Ta=25°C)

Item	Symbol	Condition	Min.	Typ.	Max.	Unit
DC Forward Voltage	V _F	I _F =20mA	2.9	3.1	3.6	V
DC Reverse Current	I _R	V _R =5V	-	-	10	μA
Luminous Intensity*	I _v	I _F =20mA	30000	36000	-	mcd
Chromaticity Coordinates*	x	I _F =20mA	-	0.27	-	
	y	I _F =20mA	-	0.28	-	
50% Power Angle	2θ _{1/2}	I _F =20mA	-	30	-	deg

*1 Tolerance of measurements of chromaticity coordinate is ±10%

*2 Tolerance of measurements of luminous intensity is ±15%

*3 Tolerance of measurements of forward voltage is ±0.1V