

■ Features

- High Luminous LEDs
- 5mm Round Standard Directivity
- UV Resistant Epoxy
- Water Clear Type

■ Applications

- Traffic Signal
- Backlighting
- Signal and channel letter
- Other Lighting

■ Outline Dimension

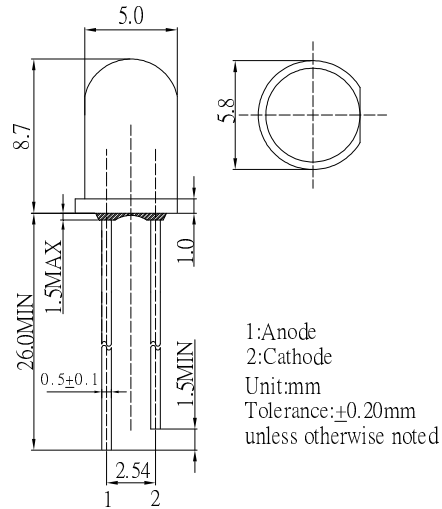

■ Absolute Maximum Rating (Ta=25°C)

Item	Symbol	Value	Unit
DC Forward Current	I _F	50	mA
Pulse Forward Current#	I _{FP}	120	mA
Reverse Voltage	V _R	5	V
Power Dissipation	P _D	130	mW
Operating Temperature	T _{opr}	-30 ~ +85	°C
Storage Temperature	T _{stg}	-40 ~ +100	°C
Lead Soldering Temperature	T _{sol}	260°C / 5sec	-

■ Directivity

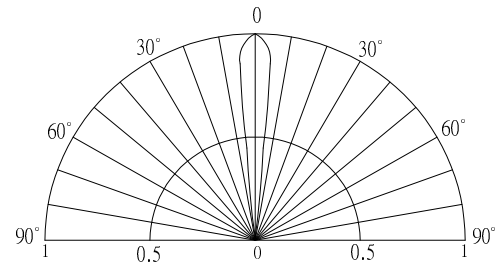

#Pulse width Max.10ms Duty ratio max 1/10

■ Electrical -Optical Characteristics (Ta=25°C)

Item	Symbol	Condition	Min.	Typ.	Max.	Unit
DC Forward Voltage	V _F	I _F =20mA	1.8	2.1	2.6	V
DC Reverse Current	I _R	V _R =5V	-	-	10	μA
Domi. Wavelength*	λ _D	I _F =20mA	600	605	610	nm
Luminous Intensity*	I _v	I _F =20mA	25000	30000	-	mcd
50% Power Angle	2θ _{1/2}	I _F =20mA	-	15	-	deg

*1 Tolerance of measurements of dominant wavelength is ±1nm

*2 Tolerance of measurements of luminous intensity is ±15%

*3 Tolerance of measurements of forward voltage is ±0.1V

■ Maximum Forward Current

