

■ **Features**

- High Luminous LEDs
- 3mm Bullet Standard Directivity
- UV Resistant Epoxy
- Water Clear Type

■ **Applications**

- Advertising Board
- Horticulture Application
- Traffic Light / Signal Light
- Beauty product
- Other Lighting

■ **Outline Dimension**

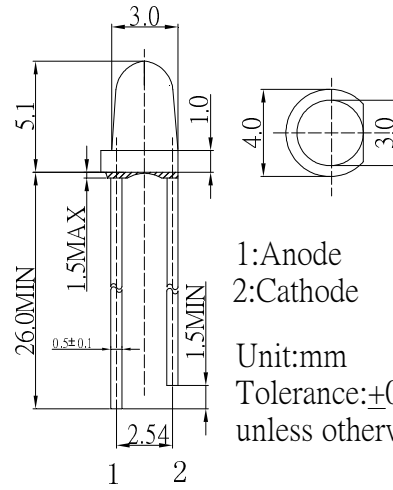

■ **Absolute Maximum Rating**

(Ta=25°C)

Item	Symbol	Value	Unit
DC Forward Current	I _F	30	mA
Pulse Forward Current*	I _{FP}	100	mA
Reverse Voltage	V _R	5	V
Power Dissipation	P _D	78	mW
Operating Temperature	T _{opr}	-30 ~ +85	°C
Storage Temperature	T _{stg}	-40~ +100	°C
Lead Soldering Temperature	T _{sol}	260°C/5sec	-

■ **Directivity**

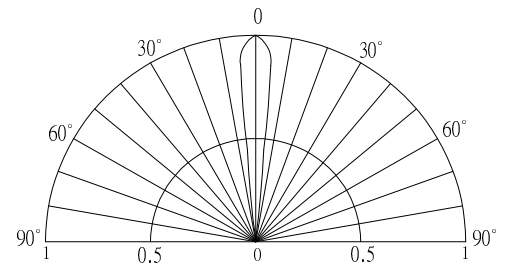

*Pulse width Max.10ms Duty ratio max 1/10

■ **Electrical -Optical Characteristics**

(Ta=25°C)

Item	Symbol	Condition	Min.	Typ.	Max.	Unit
DC Forward Voltage	V _F	I _F =30mA	1.8	2.1	2.6	V
DC Reverse Current	I _R	V _R =5V	-	-	10	μA
Luminous Flux	Φ _v	I _F =30mA	3.5	4.5	-	lm
Luminous Intensity*	I _v	I _F =30mA	18	22	-	cd
Domi. Wavelength*	λ _D	I _F =30mA	600	605	610	nm
50% Power Angle	2θ _{1/2}	I _F =30mA	-	15	-	deg

*1 Tolerance of measurements of dominant wavelength is ±1nm

*2 Tolerance of measurements of luminous intensity is ±15%

*3 Tolerance of measurements of forward voltage is ±0.1V

LED & Application Technologies

