

■Features

- Single chip
- Compact package outline
(L x W x T) of 1.6mm x 0.8mm x 0.6mm
- Compatible to IR reflow soldering.
- Water Clear Lens Type

■Applications

- Automatic Control System
- Photo Detector
- Computer I/O Peripheral

■Outline Dimension

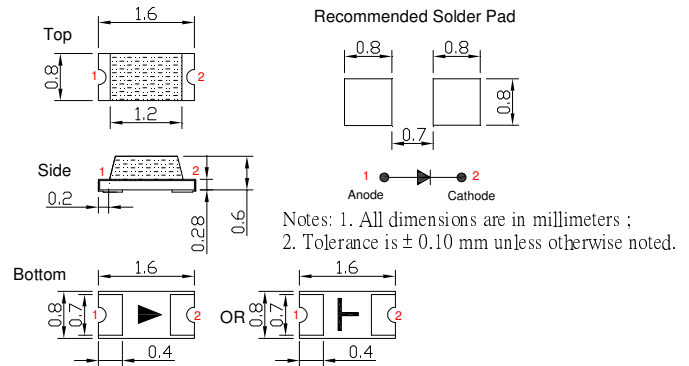

■Absolute Maximum Rating

(Ta=25°C)

Item	Symbol	Value	Unit
DC Forward Current	I _F	30	mA
Pulse Forward Current*	I _{FP}	100	mA
Reverse Voltage	V _R	5	V
Power Dissipation	P _D	45	mW
Operating Temperature	T _{opr}	-40 ~ +85	°C
Storage Temperature	T _{stg}	-40~ +85	°C
Lead Soldering Temperature	T _{sol}	260°C/5sec	-

*Pulse width Max 0.1ms, Duty ratio max 1/10

■Directivity

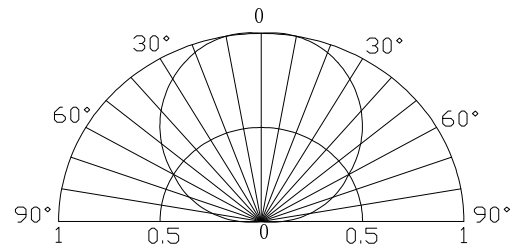

■Electrical -Optical Characteristics

(Ta=25°C)

Item	Symbol	Condition	Min.	Typ.	Max.	Unit
DC Forward Voltage	V _F	I _F =20mA	-	1.2	1.5	V
DC Reverse Current	I _R	V _R =5V	-	-	10	μA
Peak Wavelength	λ _p	I _F =20mA	-	940	-	nm
Transmit Bandwidth	λ	I _F =20mA	-	45	-	nm
Radiant Intensity	I _e	I _F =20mA	0.2	0.8	-	mW/Sr
50% Power Angle	2θ _{1/2}	I _F =20mA	-	120	-	deg

*1 Tolerance of measurements of Peak wavelength is ±1nm

*2 Tolerance of measurements of radiant intensity is ±15%

*3 Tolerance of measurements of forward voltage is ±0.1V

LED & Application Technologies

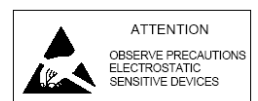

■ Typical Electrical/Optical/Characteristics Curves

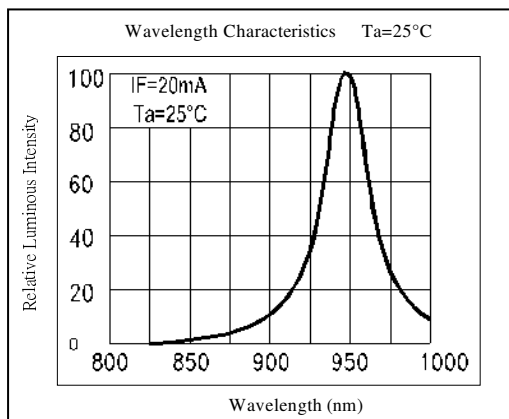
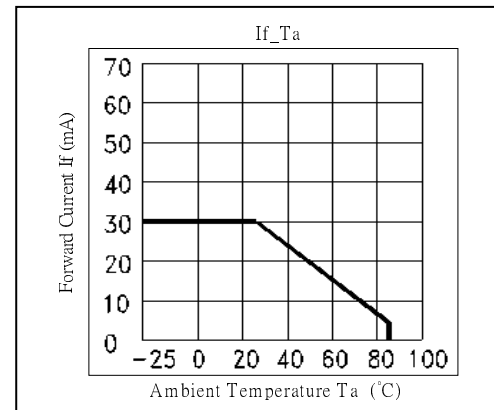
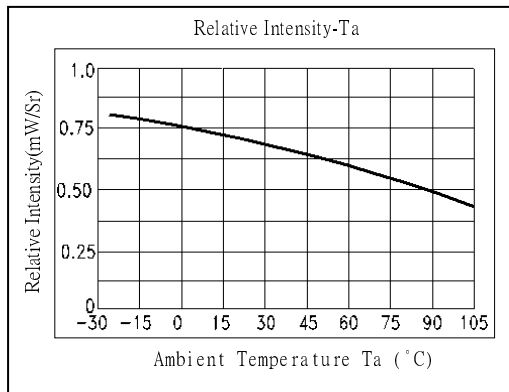
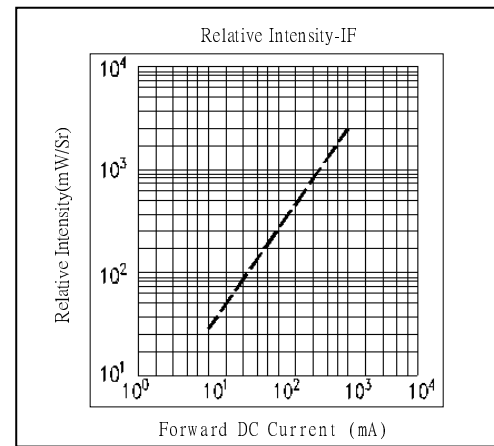
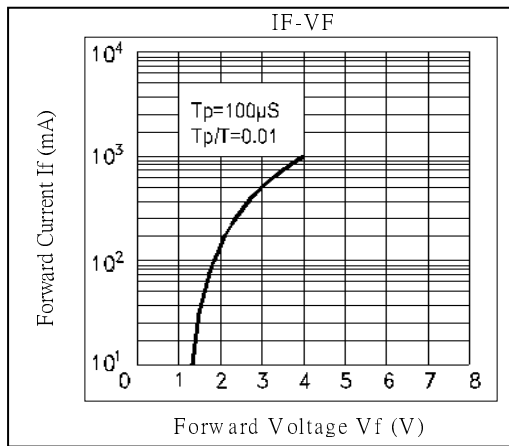

■ Soldering Conditions

Reflow Soldering		Hand Soldering	
Pre-Heat	180 ~ 200°C	Temperature Soldering time	350°C Max. 3 sec. Max. (one time only)
Pre-Heat Time	120 sec. Max.		
Peak temperature	260°C Max.		
Dipping Time	10 sec. Max.		
Condition	Refer to Temperature-profile		

• Reflow Soldering Condition(Lead-free Solder)

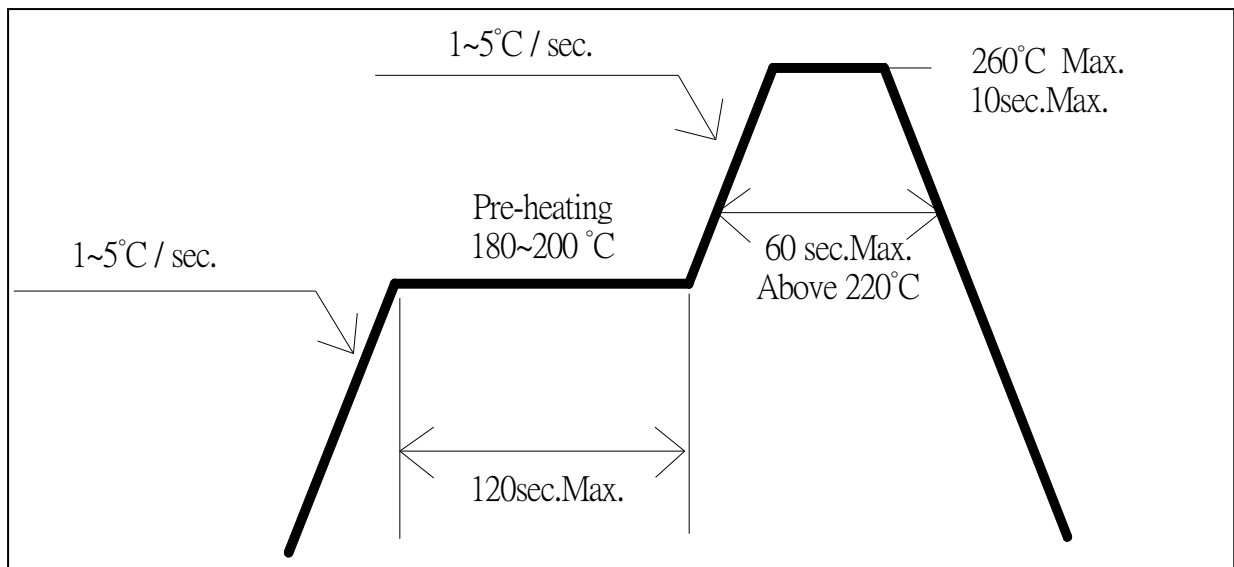

- *Recommended soldering conditions vary according to the type of LED
- *Although the recommended soldering conditions are specified in the above table, reflow, or hand soldering at the lowest possible temperature is desirable for the LEDs.
- *A rapid-rate process is not recommended for cooling the LEDs down from the peak temperature.
- All SMD LED products are pb-free soldering available.
- Occasionally there is a brightness decrease caused by the influence of heat or ambient atmosphere during air reflow. It is recommended that the User use the nitrogen reflow method.
- Repairing should not be done after the LEDs have been soldered. When repairing is unavoidable a double-head soldering iron should be used. It should be confirmed beforehand whether the characteristics of the LEDs will or will not be damaged by repairing.
- Reflow soldering should not be done more than two times.
- When soldering, do not put stress on the LEDs during heating.
- After soldering, do not warp the circuit board.

TAPING

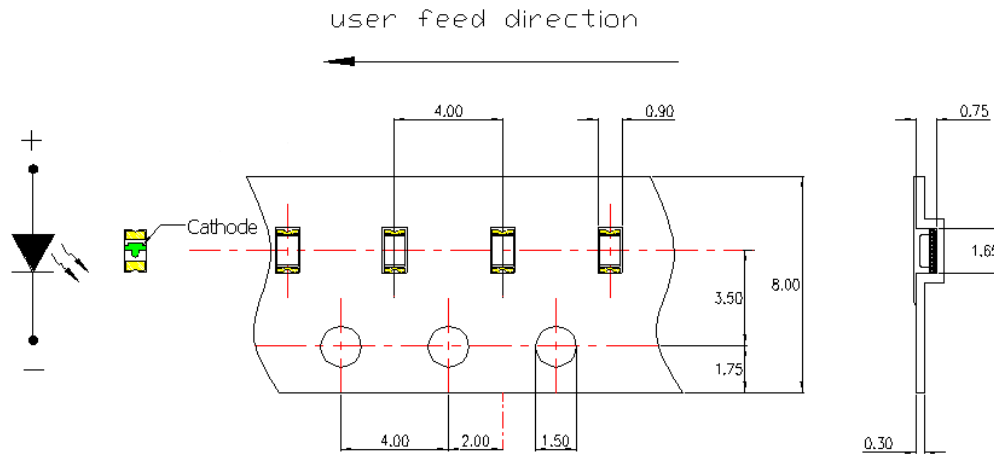

■ Reel Dimensions

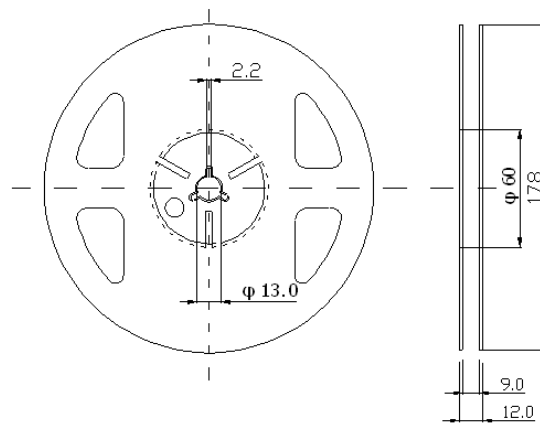

■ Moisture Resistant Packaging

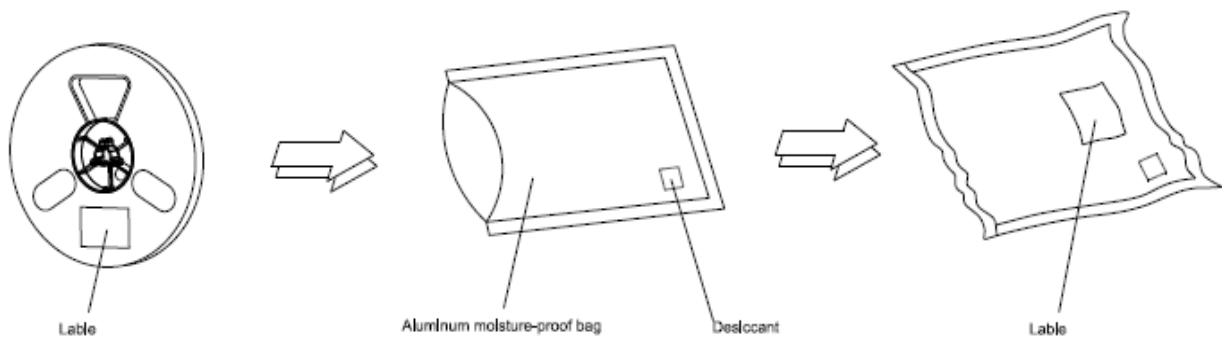

Notes:

1. Unit: mm

■ **Cautions:**

1. After open the package, the LED's floor life is 4 Weeks under 30°C or less and 60%RH or less(MSL:2a).
2. Heat generation must be taken into design consideration when using the LED.
3. Power must be applied resistors for protection, over current would be caused the optic damage to the devices and wavelength shift.
4. Manual tip solder may cause the damage to Chip devices, so advised that heat of iron should be lower than 15W with temperature control under 5 seconds at 230-260 deg. C. (The device would be got damage in re working process, recommended under 5 seconds at 230-260 deg. C)
5. All equipment and machinery must be properly grounded. It is recommended to use a wristband or anti-electrostatic glove when handing the LED.
6. Use IPA as a solvent for cleaning the LED. The other solvent may dissolve the LED package and the epoxy, Ultrasonic cleaning should not be done.
7. Damaged LED will show unusual characteristics such as leak current remarkably increase, turn-on voltage becomes lower and the LED get unlight at low current.