

■ **Features**

- High-power LED
- Long lifetime operation
- Typical viewing angle : 140deg
- RoHS compliant
- Possible to attach to heat sink directly without using print circuit board.

■ **Applications**

- Indoor & outdoor lighting
- Stage lighting
- Reading lamps
- Display cases, furniture illumination, marker
- Architectural illumination
- Spotlights

■ **Outline Dimension**

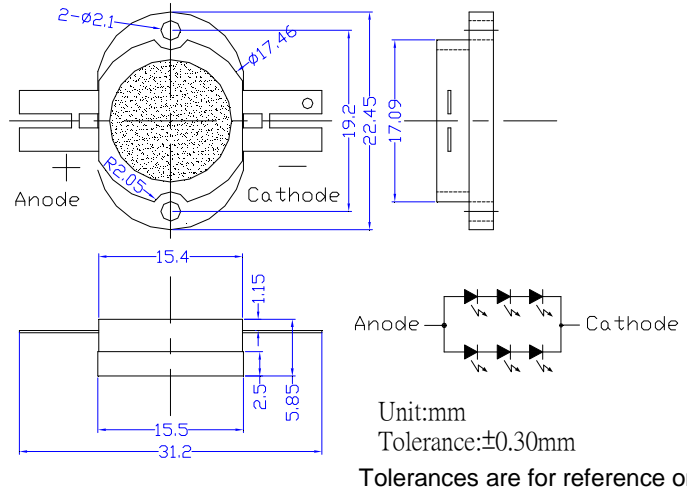

■ **Absolute Maximum Rating**

(Ta=25°C)

Item	Symbol	Value	Unit
DC Forward Current *1	I <sub>F</sub>	1,400	mA
Pulse Forward Current*2	I <sub>FP</sub>	2,000	mA
Reverse Voltage	V <sub>R</sub>	15	V
Power Dissipation*1	P <sub>D</sub>	17,640	mW
Operating Temperature	T <sub>opr</sub>	-30 ~ +85	°C
Storage Temperature	T <sub>stg</sub>	-40~ +100	°C
Lead Soldering Temperature	T <sub>sol</sub>	260°C /5sec	-

\*1, Power dissipation and forward current are the value when the module temperature is set lower than the rating by using an adequate heat sink.

\*2, Pulse width Max.10ms Duty ratio max 1/10

■ **Electrical -Optical Characteristics**

(Ta=25°C)

Item	Symbol	Condition	Min.	Typ.	Max.	Unit
DC Forward Voltage	V <sub>F</sub>	I <sub>F</sub> =1000mA	9.6	11.0	12.6	V
DC Reverse Current	I <sub>R</sub>	V <sub>R</sub> =15V	-	-	20	μA
Luminous Flux	Φ <sub>v</sub>	I <sub>F</sub> =1000mA	670	765	-	lm
Color Temperature	CCT	I <sub>F</sub> =1000mA	-	3000	-	K
Chromaticity Coordinates*	x	I <sub>F</sub> =1000mA	-	0.45	-	
	y	I <sub>F</sub> =1000mA	-	0.41	-	
50% Power Angle	2θ <sub>1/2</sub>	I <sub>F</sub> =1000mA	-	140	-	deg

Note: Don't drive at rated current more than 5s without heat sink for High Power series.

\*1 Tolerance of measurements of chromaticity coordinate is ±10%

\*2 Tolerance of measurements of luminous flux is ±15%

\*3 Tolerance of measurements of forward voltage is±0.1V

■ **Directivity**

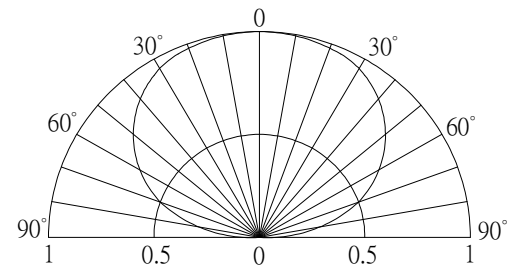

■ **Heat design**

The following pictures show some measurements of mounted 5W Led on the heat sink for each board A and B (See Fig 1) with using thermograph to make an observation about heat distribution. Each boards is tested at various current conditions.

As a result, LED needs larger heat sink as much as possible to reduce its own case temperature.

**Fig. 1 Configuration pattern examples for board assembly**

Board	LED power	Material	Surface area (mm <sup>2</sup> ) Min.
A	5W	Al	20,600
B	10W	Al	41,200
C	25W	Al	103,000
D	50W	Al	206,000
E	100W	Al	412,000
F	200W	Al	824,000
G	300W	Al	1236,000

Above tested LED device is attached with adhesive sheet to the heatsink.

For reference's sake, Tj absolute maximum rating is defined at 115°C as a prerequisite on design process of 5W LED.

**<Fig.2> Board A (surface area=10,300mm<sup>2</sup>)**

**<Fig.3> Board B (surface area=20,600mm<sup>2</sup>)**

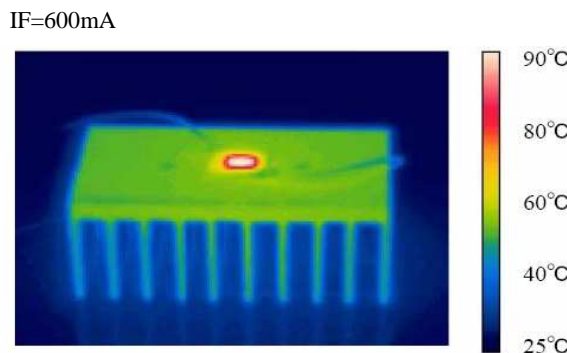
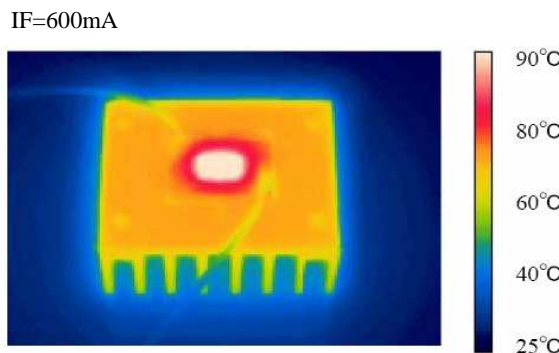
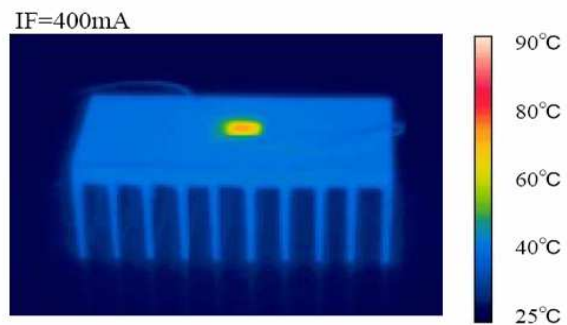
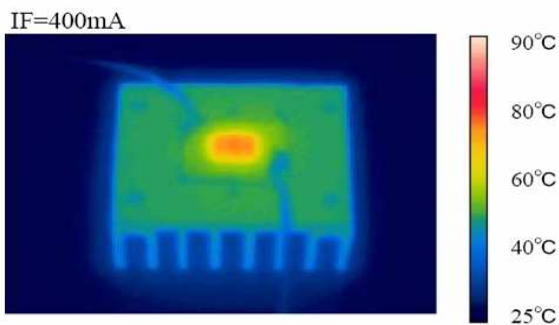
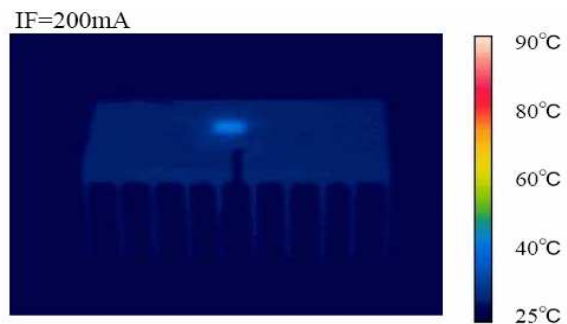
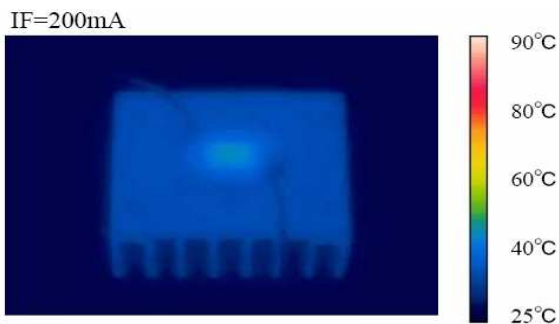

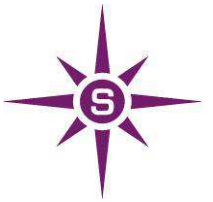

### ■ Heat design → Design flow chart

